

OUTLINE DIMENSIONS
3-PHASE INDUCTION MOTOR

MOTOR TYPE:

FRAME NO. 256T

Totally Enclosed Fan-Cooled Type.Squirrel-Cage Rotor.

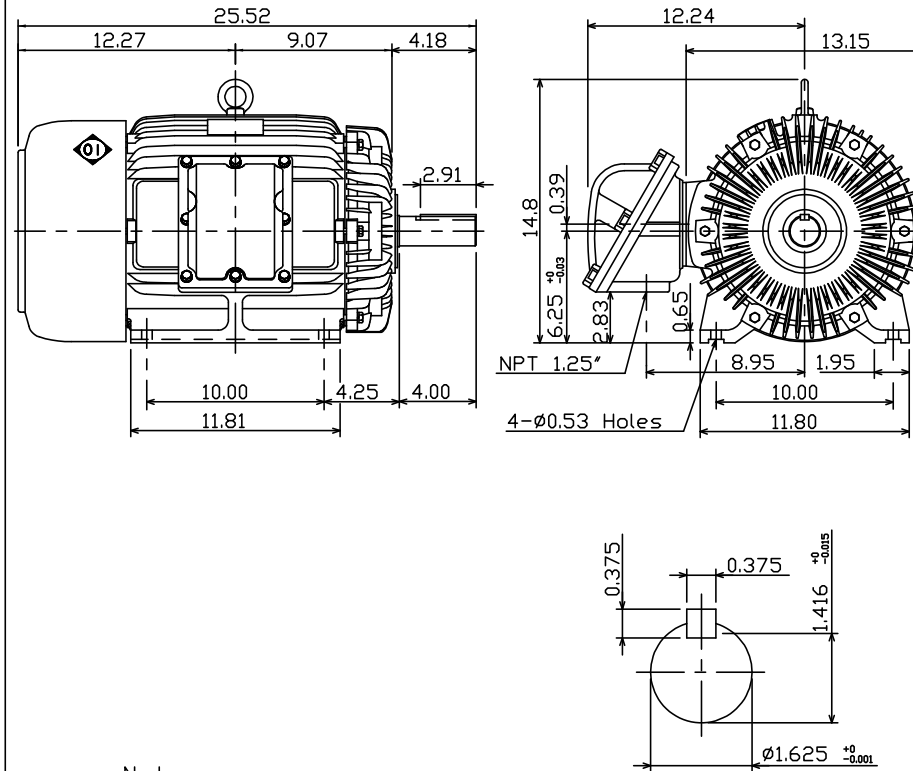

Note:

1. Explosion-proof:
Class I Group C,D and
Class II Group E,F,G.

**BROOK
CROMPTON**

DWG NO.